

Continuum™ Systems

Advanced MIG Welding Systems 

Quick Specs

Heavy Industrial Manufacturing

Construction equipment
Automotive components
Recreational vehicles
Farm machinery
Office furniture
Mining machinery
Industrial fabrication

Processes

Advanced MIG processes:
Accu-Pulse® pulsed MIG (GMAW-P)
Versa-Pulse™
RMD®
MIG (GMAW)
High-deposition MIG (GMAW)
Flux-cored (FCAW)
Air carbon arc (CAC-A)
350: Rated for 1/4-inch carbons
500: Rated for 3/8-inch carbons

Input Power

Auto-Line™ 230–575 V, 3-phase, 50/60 Hz

Rated Output

350: 350 A at 100% duty cycle
500: 500 A at 100% duty cycle

Output Range

350: 20–400 A, 10–44 V
500: 20–600 A, 10–44 V

Take your welding to the next level

Advanced industrial welding solution improves productivity through weld quality, ease of use and system flexibility.

The Continuum system delivers exceptional arc performance with less spatter and higher-quality welds on both thin and thick metals. With user-friendly controls and system modularity, Continuum will make challenging jobs easier, and improve productivity — giving you a competitive advantage.

Insight

Integrated Welding Intelligence™ solutions deliver information to measure and improve your welding operation. See page 6 for more information.



New standard for productivity and weld quality



Reduce set-up time



Easy to add capabilities

Continuum 500 MIGRunner™ package shown (cable hanger, MIG 4/0 kit and motor cable not pictured). Filler metal sold separately.



Power source is warranted for three years, parts and labor.
Original main power rectifier parts are warranted for five years.
Gun warranted for 90 days, parts and labor.



Miller Electric Mfg. LLC
An ITW Welding Company
1635 West Spencer Street
P.O. Box 1079
Appleton, WI 54912-1079 USA

Equipment Sales US and Canada
Phone: 866-931-9730
FAX: 800-637-2315
International Phone: 920-735-4554
International FAX: 920-735-4125

MillerWelds.com



Continuum™ System Features

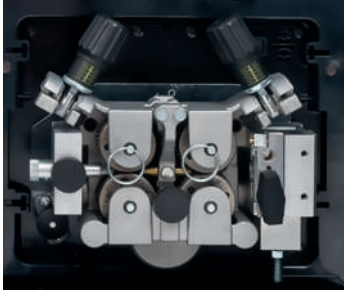

Tru-Feed™ technology provides precise feeding operation for stable arc performance.

- **Low-inertia motor** provides faster response for the best arc starts with the least amount of spatter.
- **Balanced-pressure drive-roll design and tensioners** feed wire in its truest and straightest form for consistent feedability, resulting in better welding performance.

Spring-loaded Accu-Mate™ connection aligns gun perfectly in the drive-roll carrier — preventing the gun from being pulled loose and providing consistent wire feeding.



Quick-change dual-bearing drive rolls give you more consistent wire feeding.

Drive rolls and guides are common with other Miller industrial feeders (use existing, not new parts).

Inlet guide installation is toolless.

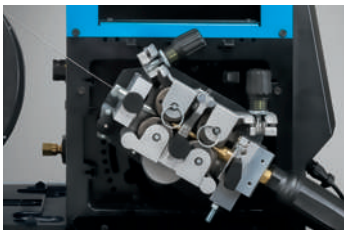

Toolless positive-locking rotatable drive assembly allows operator to rotate the drive, eliminating severe bends in the wire feed path. This extends gun-liner life and aids in feeding difficult wires.



Display and controls for program select, volts/arc length and wire feed speed

Memory buttons for quick program recall

LCD setup screen

- For easy selection of welding processes and functions
- Industrial design, full color display

Arc control to fine tune the welding arc

Trigger hold, jog and purge buttons



Quality-engineered rear cable management protects your connections to keep you productive.

Wind Tunnel Technology™

Internal air flow that protects electrical components and PC boards from dirt, dust, debris — greatly improving reliability.

Fan-On-Demand™ operates only

when needed reducing noise, power consumption, and the amount of airborne contaminants pulled through the machine.

AUTO-LINE™
TECHNOLOGY

Allows for any input voltage hookup (230–575 V) with no manual linking. Provides convenience in any job setting and eliminates weld defects caused by dirty or unreliable power.

Continuum™ System Advantages

Intuitive user interface makes Continuum easier to use



Reduce set-up time

Simple to set up and adjust with minimal training.

LCD display shows complete words, graphics and numeric values.

Memory buttons allow weld operators to quickly and easily change programs.

Remote connection to easily view and adjust machine parameters from virtually anywhere in the world using any Web-enabled device.

Easily update firmware, configure machine settings, view diagnostics and more.

USB functionality allows custom settings to be saved on a USB flash drive for duplicating settings for a specific operator, job, or to manage fleet configurations. The USB port is also used to update software.

Ability to set locks and limits for improved quality control using webpages.



The Continuum user interface makes machine operation easier than ever.

Easy system interface and configuration via the Continuum webpage interface

- To use the webpage interface connect to the Continuum power source one of three ways:



Connect to factory network via Wi-Fi



Connect to factory network via Ethernet cable



Direct connect to PC via Ethernet cable (see page 10 for recommended Ethernet cable)

- Select language preference
- Check system status and vital information
- Configure machine settings
 - Locks and limits
 - Enable programs
 - Enable processes
- Set up programs
- View productivity information and various logs
 - Resettable/lifetime arc hours
 - Error logs
 - Heat input
 - And more
- Great for validating proper system setup as well as troubleshooting issues

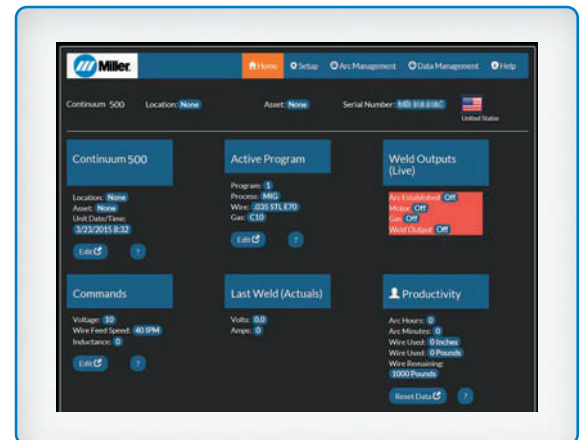

Continuum grows with your business needs

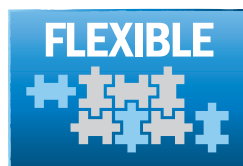

Easy to add capabilities

Adaptable to a variety of weld cell configurations and requirements.

Control interface can be located on the bench feeder or on the remote operator interface (ROI) (see page 11 for configurations).

Welding Intelligence™ Improve your welding operations by increasing productivity, improving quality and managing costs.

Easily add processes and programs via the USB interface.

Wire feeder is easily configurable for standard spool sizes, 60-pound spools or bulk-feeding systems.

Auxiliary power outlets (factory option) for convenient operation of 120-volt electrical devices.

Note: Outlets are for low-power current devices like Continuum cooler or laptops. NOT meant for high-power devices like grinders.

Continuum™ System Processes

Take the performance of each process to the highest level

Accu-Pulse®

- The most popular process for majority of industrial welding applications
- Most adaptive arc on 16 gauge (1.6 mm) and thicker
- Designed for all weld positions

Versa-Pulse™

- Fast, low-heat, low-spatter process — for materials 1/4 inch (6.35 mm) and thinner
- Great for gap filling
- Shortest arc length/lowest pulse voltage for lower heat and lower spatter at higher speeds

RMD®

- Lowest heat process, best for gap handling
- Limited travel speed

MIG

- Lower spatter than traditional MIG welders
- Better arc performance with silicon bronze and coated materials

High-deposition MIG

- Higher deposition rates than standard spray transfer on thicker materials
- Designed for welding applications in which spray transfer is preferred

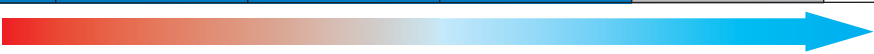

Best For	Standard Spray	High-Deposition MIG	Accu-Pulse	Versa-Pulse	Short Circuit	RMD
Deposition	A	A	A	B	D	D
Gap Filling	D	D	B	B	A	A
Low Heat Input	D	C	B	A	A	A
Out-of-Position Welds			A	B	B	B
Low Spatter	A	A	A	B	C	B
Thick Metals	A	A	A	C	D	D
Thin Metals			B	A	A	A
Increased Travel Speed	A	A	A	A	B	C

HOT  COLD

Ratings A, B, C, and D are relative values. An “A” rating indicates a best fit between your performance needs and process. A “blank” rating indicates that the process is not recommended for that application.

Continuum™ Power Source Specifications (Subject to change without notice.)



Model	Amp/Volt Ranges	Rated Output	Amps Input at Rated Output, 50/60 Hz, 3-Phase							Max. Open-Circuit Voltage	Dimensions	Net Weight
			230 V	380 V	400 V	460 V	575 V	KVA	KW			
Continuum 350	20–400 A 10–44 V	350 A at 31.5 VDC, 100% duty cycle	36.7 0–1*	21.8 0–1*	20.8 0–1*	18.8 0–1*	14.6 0–1*	14.4 0.8*	13.8 0.17*	71 VDC	H: 27.19 in. (691 mm) (including lift eye)	127 lb. (57.6 kg)
Continuum 500	20–600 A 10–44 V	500 A at 39 VDC, 100% duty cycle	57.6 0–1*	34.7 0–1*	33.2 0–1*	28.9 0–1*	23.3 0–1*	23.1 0.8*	21.9 0.17*	71 VDC	W: 17.5 in. (444 mm) D: 28.13 in. (714 mm)	148 lb. (67.1 kg)

*While idling.

Certified by Canadian Standards Association to both the Canadian and U.S. Standards.

Continuum™ Feeder Specifications (Subject to change without notice.)



Input Power	Welding Power Source	Input Welding Circuit Rating	Wire Feed Speed	Wire Diameter Capacity	Maximum Spool Size Capacity	Dimensions	Net Weight
50 VDC	Continuum 350 or 500	500 A at 100% duty cycle	Standard 50–1,000 ipm (1.27–25.4 m/min.)	.035–5/64 in. (0.9–2.0 mm)	18 in. (457 mm) 60 lb. (27 kg)	H: 13.81 in. (351 mm) Single W: 16.31 in. (414 mm) Dual W: 17 in. (432 mm) D: 29.69 in. (754 mm)	Single 43 lb. (19.5 kg) Dual 61.5 lb. (27.9 kg)

Certified by Canadian Standards Association to both the Canadian and U.S. Standards.

Performance Data

Duty Cycle Chart

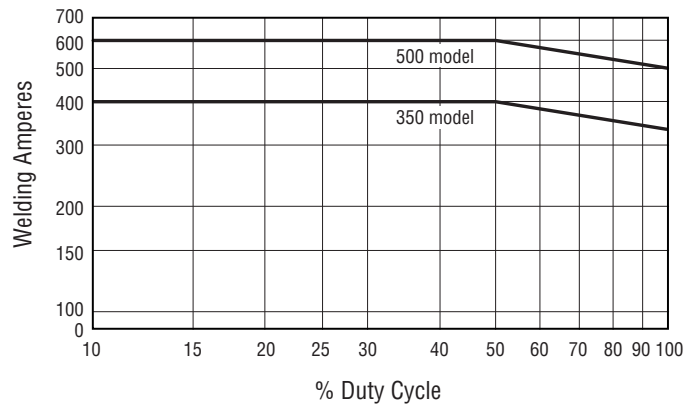

Mounting Specifications

Bottom View

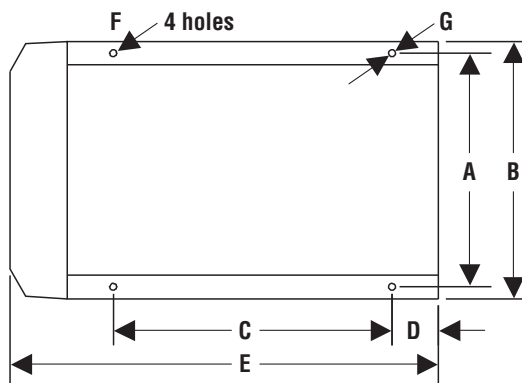

- A. 16.093 in. (409 mm)
- B. 17.5 in. (444 mm)
- C. 17.375 in. (441 mm)
- D. 2.281 in. (58 mm)
- E. 26.172 in. (665 mm)
- F. .468 in. (12 mm) dia.
- G. .468 in. x 1 in. (12 x 25 mm)

Height: 27.187 in. (691 mm)
Width: 17.5 in. (444 mm)
Depth: 28.125 in. (714 mm)

Insight Welding Intelligence™

Insight Welding Intelligence is a portfolio of solutions that manage weld data to help our customers get more done, produce higher-quality welds and control costs. Learn more at MillerWelds.com/insight



Insight Core™ (Standard)

Insight Core reports welding productivity from a web-based application to measure and improve your operation.

- **Measure welding productivity.** See each welder's arc-on time to set baselines, plan improvements and measure goals.
- **View easy-to-understand reports.** Dashboards show trends and develop reports. Compare welders, cells and plants.
- **Identify welding costs.** Make improvements to reduce expenses.
- **Easily install and use.** Just connect it to the internet. View secure data on any web-connected device anywhere.



Insight Centerpoint™ (Optional)

Insight Centerpoint is the real-time welder feedback solution that provides arc data monitoring, guidance and control within the weld cell.

- **Reduce training time.** Guide welders through the weld sequence in real time.
- **Ensure quality welds.** Contain weld defects early and control your weld operation by monitoring every parameter of every weld.
- **Reduce costs.** Alert welders if a weld is missed or is outside of acceptable parameters, allowing it to be corrected cost-effectively.

Cost of a missed weld or defect

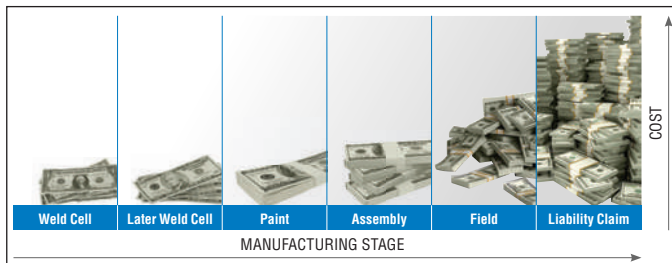

Insight Centerpoint provides real-time guidance in the weld cell so welders can correctly complete even complex weld sequences. It also delivers control of weld operations by monitoring every weld and immediately alerting welders to missed/out-of-parameter welds — so weld operations can contain weld errors and minimize the cost of rework.

- Guide new inexperienced welders through the manufacturing process by presenting them with visual work instructions, reducing training time and out-of-date work instructions
- Centerpoint can prevent the next weld from occurring if missing or out-of-spec welds are detected, to alert and direct the operator to which weld(s) are out of parameter, reducing inspection time
- Repair can be done at the weld cell before paint, final assembly, or finished product delivery, which significantly reduces the cost of rework and improves overall parts quality

Insight Centerpoint Ordering Information

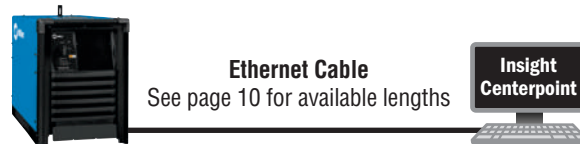

Ethernet Cable

See page 10 for available lengths



Centerpoint 10 License and Activation 951809

Gas Flow Sensors

301472 Continuum single-wire feeder sensor kit with gas sensor for bench-style feeders (order two for dual-wire feeders, works with Insight Core and Centerpoint)

301478 Continuum wire drive sensor kit with gas sensor for boom-mounted wire drive motors (works with Insight Core and Centerpoint)



BTB T Series



BTB C Series

Insight BTB T Series or C Series LTD Guns

Customize your MIG gun at Tregaskiss.com. Insight LTD guns provide welding operators point-of-use control to interact with the Insight Centerpoint PC Application.

Insight LTD Remote 301383

Wired remote that can be added to any MIG gun. Provides controls for Insight Centerpoint.

Continuum™ Swingarc™

Continuum Swingarc™

Boom-Mounted Wire Feeders

951635001 12 ft. (3.7 m) single-wire

951636001 16 ft. (4.9 m) single-wire

951725001 12 ft. (3.7 m) dual-wire

Requires pipe post **OR** pipe post and Swingpak for mounting. See below.

Pipe Post

149838 4 ft. (1.2 m) pipe post

149839 6 ft. (1.8 m) pipe post

Required for mounting 12- or 16-foot Swingarc booms. Pipe posts have 18-inch base plates which allow the post to be bolted to floor or optional Swingpak base.

Swingpak™ Base 183997

Optional base for Swingarc booms.

Pipe post easily bolts to base. Base must be bolted to the floor for 16-foot Swingarc.



Single/Dual Spool Carrier 300352

For 6 ft. pipe post only. Pipe post not included, order separately.

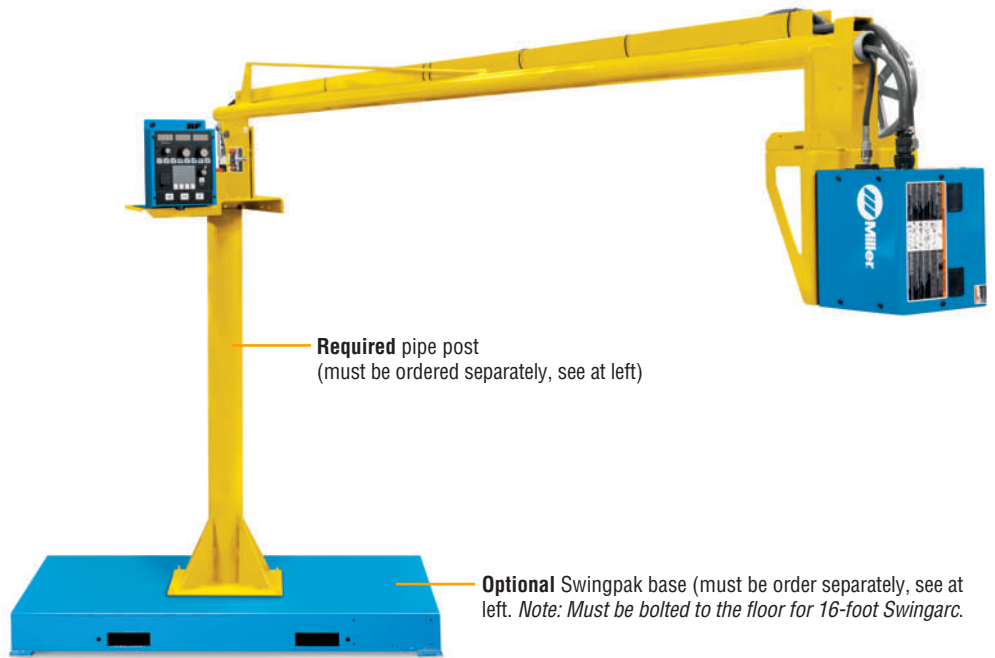

Required pipe post
(must be ordered separately, see at left)

Optional Swingpak base (must be order separately, see at left. *Note: Must be bolted to the floor for 16-foot Swingarc.*)

12- or 16-foot booms to accommodate a wide variety of semiautomatic applications, including large weldments and hard to reach areas. *Note: Dual-wire model only available with a 12-foot boom.*

360-degree rotation and 60-degree lift angle maximizes your work area (24- or 32-foot diameter work area).

Unique counterbalanced boom makes it easy to raise and lower boom and automatically holds its position.

In-boom cable routing organizes hoses and cables, preventing damage and maintaining an orderly work cell.

Specifications (Subject to change without notice.)

Component	Dimensions	Net Weight
4 ft. pipe post	H: 4 ft. (1.2 m)	110 lb. (49.9 kg)
6 ft. pipe post	H: 6 ft. (1.8 m)	130 lb. (59 kg)
Swingpak base	L: 65 in. (1.7 m), W: 50.875 in. (1.3 m)	285 lb. (129 kg)

Note: Swingarc includes 10-foot gas hose and 10-foot weld cable for the operator to hook up.

Continuum™ Packages

951853001
package shown



Steel (push-only) MIGRunner™ Packages

951852001 Continuum 350 MIGRunner, air cooled

951853001 Continuum 500 MIGRunner, air cooled

Packages include:

- Continuum welding power source with running gear/cylinder rack and cable hanger
- Continuum single-wire feeder
- 15 ft. (4.6 m) Bernard® BTB Gun 400 A with AccuLock™ consumables
- 3 ft. (0.9 m) control/motor cable
- Industrial MIG 4/0 kit for single-wire feeders consisting of flowmeter regulator with 10 ft. (3 m) gas hose, 10 ft. (3 m) 4/0 feeder weld cable with lugs, and 15 ft. (4.6 m) work cable with 600-amp C-clamp
- .035/.045 in. V-groove drive rolls

951866001
package shown



Multi-material (push-pull) MIGRunner™ Packages

951865001 Continuum 350 MIGRunner, air cooled

951866001 Continuum 500 MIGRunner, air cooled

Packages include:

- Continuum welding power source with running gear/cylinder rack and cable hanger
- Continuum dual-wire feeder
- 25 ft. (7.6 m) XR-Aluma-Pro™ Plus push-pull gun
- 15 ft. (4.6 m) Bernard® BTB Gun 400 A with AccuLock™ consumables
- 3 ft. (0.9 m) control/motor cable
- Industrial MIG 4/0 kit for dual-wire feeders consisting of two flowmeter regulators with two 10 ft. (3 m) gas hoses, 10 ft. (3 m) 4/0 feeder weld cable with lugs, and 15 ft. (4.6 m) work cable with 600-amp C-clamp
- .035/.047 in. U-groove and .035/.045 in. V-groove drive rolls

Bernard® Best of the Best (BTB) MIG Gun



Bernard BTB Gun 400 A Q4015VS9EMQ

C Series straight handle MIG gun ships with Continuum feeders and has the best of all Bernard options. This 400-amp, air-cooled MIG gun is recommended for heavy manufacturing environments and features a fixed 60-degree neck with aluminum armor. It has an ergonomic handle with rubber grip and rear ball and socket swivel to maximize comfort while welding.

Now available with AccuLock S consumables with rear-loading Bernard conventional liners.

- **AccuLock nozzle, contact tip and newly designed diffuser compatible** with a Bernard conventional liner are included in the Continuum package
- **Diffuser allows user to easily upgrade** to the full AccuLock S consumable system with front-loading AccuLock S liner
- **Coarse thread on contact tip** speeds tip replacement.
- **Provides error-proof liner trimming every time** when used with the full AccuLock S consumable system — no measuring required. Also provides up to 2–3 times extended contact tip life.

XR™ Push-Pull Guns (ONLY for use with left-hand drive of dual-wire bench feeders.)



XR-Aluma-Pro™ Plus Guns

- 301575** 15 ft. (4.6 m), air-cooled
- 301574** 25 ft. (7.6 m), air-cooled
- 301739** 35 ft. (10.7 m), air-cooled
- 301576** 15 ft. (4.6 m), water-cooled
- 301577** 25 ft. (7.6 m), water-cooled
- 301740** 35 ft. (10.7 m), water-cooled



XR™-Pistol Plus Guns

- 300753** 15 ft. (4.6 m), air-cooled
- 300754** 25 ft. (7.6 m), air-cooled
- 300757** 25 ft. (7.6 m), water-cooled

Available in air- or water-cooled versions in multiple lengths for extended reach with trouble-free, reliable feeding.

Aluminum-series-specific tension setting ensures smooth wire feeding performance with 4000 or 5000 series aluminum wires.

Replaceable feed cable liner is designed to provide consistent arc performance. It also reduces parts cost and service time by allowing a simple means of removing and replacing liner and not the complete feed cable.

Easy-to-rotate self-seating head tube allows for better access into tight spots, providing excellent current transfer.

Isolated common knurled drive roll helps reduce wear, reducing down time and cost.

Serviceability. These guns feature a full-length hook-and-loop seamed leather jacket with integrated strain reliefs for easy cable maintenance and protection. Additionally, the Aluma-Pro Plus guns feature quick connections between the control cable and electrical components (trigger, motor, potentiometer).

Specifications (Subject to change without notice.)

Model	Welding Current Rating	Wire Feed Speed	Wire Type and Diameter Capacity	Dimensions	Net Weight (Gun only)
XR-Aluma-Pro Plus (Air-cooled)	300 A at 100% duty cycle	70–900 ipm (1.8–23 m/min.) dependent on feeder used	.030–1/16 in. (0.8–1.6 mm) aluminum wire Requires gun wire kit 230708 to run 1/16 in. (1.6 mm) wire	H: 5 in. (127 mm) W: 2.5 in. (64 mm) D: 17 in. (432 mm)	2.5 lb. (1.1 kg)
XR-Aluma-Pro Plus (Water-cooled)	400 A at 100% duty cycle	70–900 ipm (1.8–23 m/min.)		H: 5 in. (127 mm) W: 2.5 in. (64 mm) D: 17 in. (432 mm)	2.9 lb. (1.3 kg)
XR-Pistol Plus (Air-cooled)	200 A at 100% duty cycle 250 A at 60% duty cycle	70–900 ipm (1.8–23 m/min.)	.030–1/16 in. (0.8–1.6 mm) aluminum wire Requires gun wire kit 230708 to run 1/16 in. (1.6 mm) wire	H: 7.375 in. (187 mm) W: 1.875 in. (48 mm) D: 10.625 in. (270 mm)	2.2 lb. (1 kg)
XR-Pistol Plus (Water-cooled)	400 A at 100% duty cycle				2.4 lb. (1.1 kg)

Certified by Canadian Standards Association to both the Canadian and U.S. Standards. Conforms to European standards.

Note: XR-Aluma-Pro Plus and XR-Pistol Plus guns are only compatible with MPa Plus feeders and the left-hand drive of Continuum dual-wire bench feeders.

Genuine Miller® Accessories



Continuum™ Running Gear/Cylinder Rack 301264

Small footprint and easily maneuverable, with cylinder rack low enough that you do not have to lift bottles.



Industrial MIG 4/0 Kit

300390 For single-wire feeders

300957 For dual-wire feeders

Consists of flowmeter regulator with 10-foot (3 m) gas hose, 10-foot (3 m) 4/0 feeder weld cable with lugs, and 15-foot (4.6 m) work cable with 600-amp C-clamp. Dual kit comes with two flowmeter regulators and gas hoses.



Continuum Handles/Cable Hanger 301585

Used to hang welding cables or MIG guns when not welding.



Hanging Bail 058435

Used for suspending feeder over work area.

Spool Covers and Cases

274613 Left cover

274611 Left case

276961 Right cover

276962 Right case

Cover and case must be ordered together.

Continuum Control/Motor Cables

263368003 3 ft. (0.9 m)

263368015 15 ft. (4.6 m)

263368025 25 ft. (7.6 m)

263368050 50 ft. (15.2 m)

263368080 80 ft. (24.4 m)

263368100 100 ft. (30.5 m)

Connects power source to feeder or remote operator interface. Also connects remote operator interface to remote motor drive.

Volt-Sense Cables

242212025 25 ft. (7.6 m)

242212050 50 ft. (15.2 m)



Ethernet Cables

300734 9.8 ft. (3 m)

300736 32.8 ft. (10 m)

Ethernet cables with M12/RJ45 connectors.

Connects power source to

Ethernet port of PC or network. For use with webpages and Insight Centerpoint™.

Coolant Systems



Continuum

Cooler 301214

For use with water-cooled torches rated up to 500 amps. Integrated

coolant flow switch ensures coolant is flowing in the system. The Continuum cooler mounts to the bottom of the Continuum power source. Power is supplied via an internal connection with the power source. Includes 6-foot (1.8 m) water hoses.





Note: QRW water hose quick connects are optional for use with Bernard® water-cooled guns.

Low-Conductivity Coolant 043810

Sold in cases of four one-gallon recyclable plastic bottles. Miller coolants contain a base of ethylene glycol and deionized water to protect against freezing to -37 degrees Fahrenheit (-38°C) or boiling to 227 degrees Fahrenheit (108°C). Also contains a compound that resists algae growth.

Drive Roll Kits and Guides

Select drive roll kits from chart below according to type and wire size being used. Drive roll kits include four drive rolls, necessary guides and feature an anti-wear sleeve for inlet guide.

Wire Size	V-groove for hard wire 	U-groove for soft wire or soft-shelled cored wires 	V-knurled for hard-shelled cored wires 	U-cogged for extremely soft wire or soft-shelled cored wires (i.e., hard facing types) 	U-groove for aluminum wires contains nylon guides 
.035 in. (0.9 mm)	151026	—	151052	—	265255
.040 in. (1.0 mm)	161190	—	—	—	—
.045 in. (1.1/1.2 mm)	151027	151037*	151053	151070	265256*
.052 in. (1.3/1.4 mm)	151028	—	151054	—	—
1/16 in. (1.6 mm)	151029	151039	151055	151072	265257
.068/.072 in. (1.8 mm)	—	—	151056	—	—
5/64 in. (2.0 mm)	—	—	151057	—	—
3/32 in. (2.4 mm)	—	151041	151058	—	—

*Accommodates .045- and .047-inch (3/64-inch) wire.

Nylon Wire Guides for Feeding Aluminum Wire

Wire Size	Inlet Guide	Intermediate Guide
.035 in. (0.9 mm)	221912	242417
.047 in. (1.2 mm)	221912	205936
1/16 in. (1.6 mm)	221912	205937

Note: U-groove drive rolls are recommended when feeding aluminum wire.

Wire Guides

Wire Size	Inlet Guide	Intermediate Guide
.023–.040 in. (0.6–1.0 mm)	221030	149518
.045–.052 in. (1.1–1.4 mm)	221030	149519
1/16–5/64 in. (1.6–2.0 mm)	221030	149520
3/32–7/64 in. (2.4–2.8 mm)	229919	149521

Typical Continuum™ Installations

Standard installation

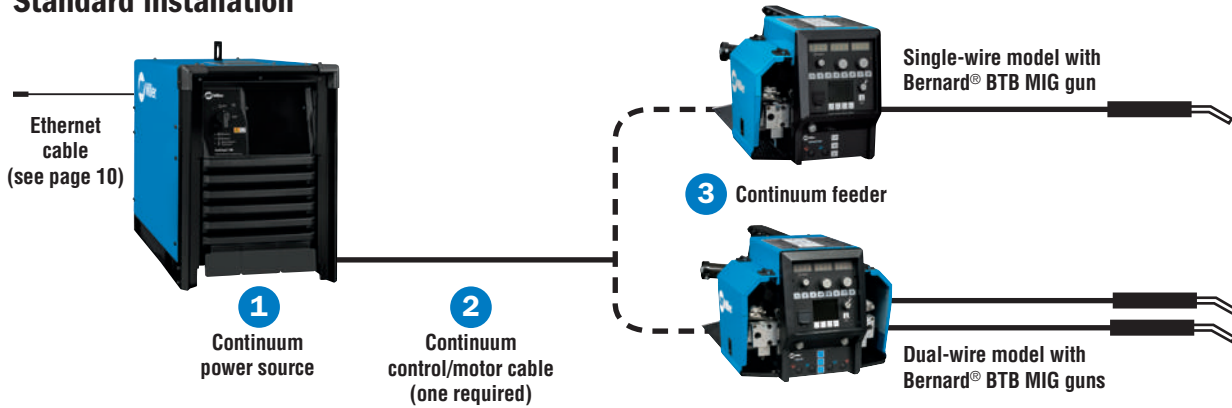

Swingarc boom-mounted installation

Accommodates a wide variety of semi-automatic applications, including large weldments and hard-to-reach areas.

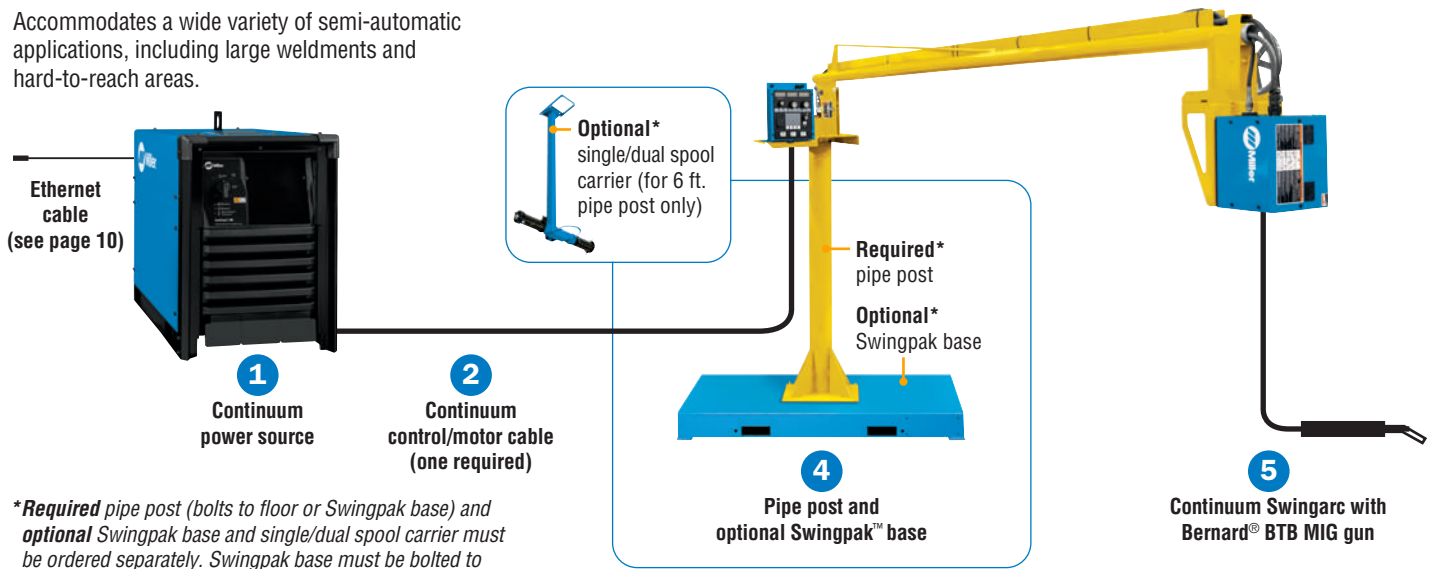

*Required pipe post (bolts to floor or Swingpak base) and optional Swingpak base and single/dual spool carrier must be ordered separately. Swingpak base must be bolted to the floor for 16-foot Swingarc. See page 8.

Remote drive motor installation

Ideal for fixed automation and boom applications where the wire drive motor is installed/controlled remotely.

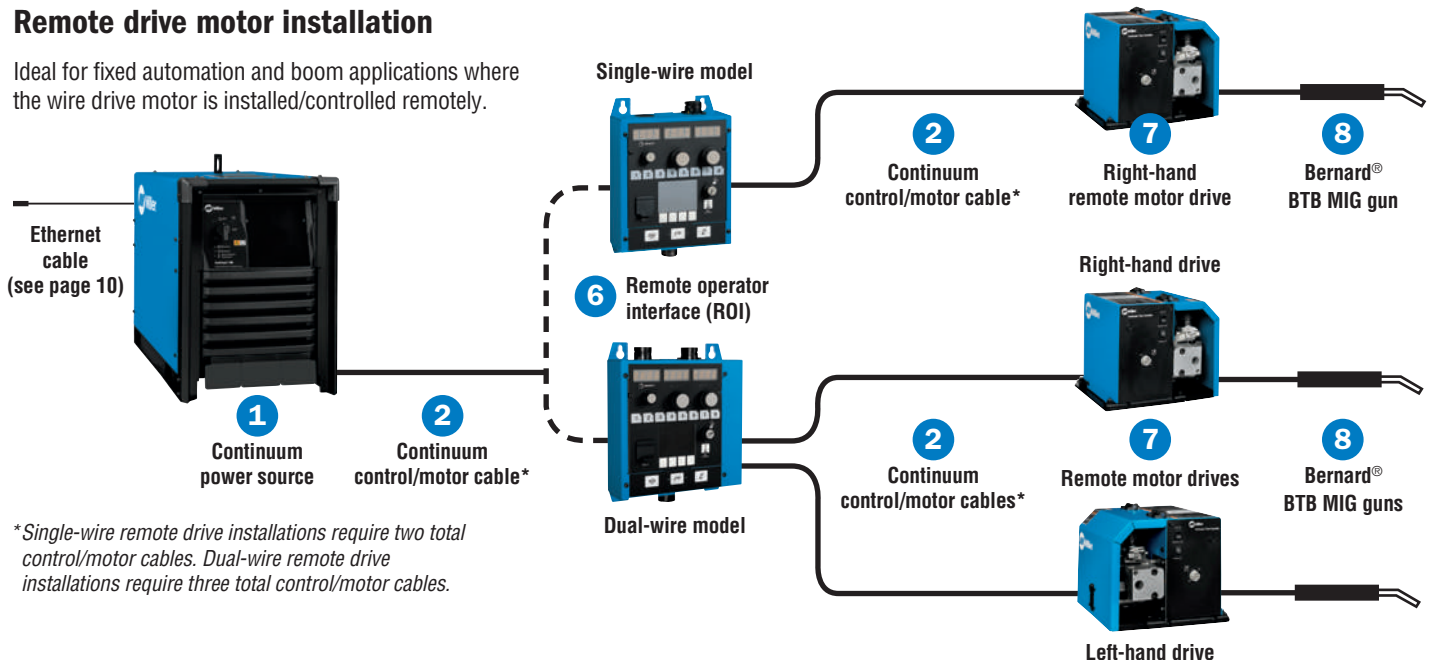

*Single-wire remote drive installations require two total control/motor cables. Dual-wire remote drive installations require three total control/motor cables.

Ordering Information

Continuum Packages	Stock No.	Description	Qty.	Price
Continuum™ 350 MIGRunner™	951852001	Push-only package. Includes single-wire bench feeder with Bernard® BTB gun with AccuLock™ consumables — see page 8 for complete description		
Continuum™ 500 MIGRunner™	951853001			
Continuum™ 350 MIGRunner™	951865001	Push-pull package. Includes dual-wire bench feeder with XR-Aluma-Pro™ Plus push-pull gun and Bernard® BTB Gun with AccuLock™ consumables — see page 8 for complete description		
Continuum™ 500 MIGRunner™	951866001			

Configure a Custom Continuum System (See corresponding item numbers in Typical Continuum Installations on page 11.)

Power Sources				
1	Continuum™ 350	907636 907636001 907637	Power source only Power source with running gear/cylinder rack Power source with auxiliary power	Auxiliary power outlets are for low-power current devices like Continuum cooler or laptops — NOT meant for high-power devices like grinders
	Continuum™ 500	907640 907640001 907641	Power source only Power source with running gear/cylinder rack Power source with auxiliary power	

Wire Feeders and Guns				
3	Continuum™ Bench-Style Wire Feeders	951631001	Single-wire model	Includes Bernard BTB Gun 400 A (two with dual-wire models) and .035/.045 in. V-groove drive rolls
		951673001	Dual-wire model	
5	Continuum™ Swingarc™ Boom-Mounted Wire Feeders	951635001	12 ft. single-wire model	
		951636001	16 ft. single-wire model	
		951725001	12 ft. dual-wire model	
6	Remote Operator Interface	301227	Control box for single-wire drive assembly	
		301434	Control box for dual-wire drive assembly	
7	Remote Motor Drive	301216	Left-hand single-wire drive assembly	
		301215	Right-hand single-wire drive assembly	
8	Bernard® BTB Gun	Q4015VS9EMQ	Push-only MIG gun	
XR™ Push-Pull Guns			ONLY for left-hand drive of dual-wire bench feeder. See page 9	

Cables				
2	Continuum Control/Motor Cables		See page 10 for available lengths	
	Volt-Sense Cables		See page 10 for available lengths	
	Ethernet Cables		See page 10 for available lengths	

Swingarc Mounting Equipment				
4	Pipe Post		Required for mounting Swingarc booms. See page 7 for available heights	
	Swingpak™ Base	183997	Optional mounting platform for pipe post	

Welding Intelligence™ Software				
	Insight Centerpoint™	951809	Centerpoint 10 license and activation for Continuum	
	Gas Flow Sensors		See page 6 (<i>contact customer service at 920-954-3809 for retrofit options</i>)	
	Insight LTD Guns		Guns provide built-in controls for Insight Centerpoint. See page 6	
	Insight LTD Remote	301383	Wired remote that can be added to any MIG gun. Provides controls for Insight Centerpoint	

Accessories				
	Running Gear/Cylinder Rack	301264	For Continuum power source	
	Industrial MIG 4/0 Kit		Available for single- and dual-wire bench feeders. See page 10	
	Continuum Cable Hanger	301585	Used to hang welding cables or MIG guns when not welding	
	Hanging Bail	058435	Used for suspending feeder over work area	
	Spool Covers		See page 10	
	Continuum Cooler	301214	Integrated 2-gallon capacity cooler for water-cooled MIG guns	
	Low-Conductivity Coolant	043810	1-gallon plastic bottle (<i>must be ordered in quantities of 4</i>)	
	Single/Dual Spool Carrier	300352	Optional spool carrier for 6 ft. pipe post	

Date: Total Quoted Price:

Distributed by:

